



Foco Embutido Redondo/Cuadrado ES

Especificaciones

Características

Alta salida de lúmenes.

Larga vida útil

Fácil instalación

Ventajas

Ahorro de hasta el 50% en comparación con el downlight convencionales.

En comparación al downlight convencional mantiene hasta 30000 horas de vida útil

Código	Descripción	Potencia (W)	Lumen (lm)	Eficacia (lm/W)	Corriente (mA)	TC (K)	Factor de Potencia
8.02.37.006.1	Panel Led Embutido Redondo ES	6	380	63	55	3000	0.45
8.02.37.006.2	Panel Led Embutido Redondo ES	6	400	67	55	4000	0.45
8.02.37.006.3	Panel Led Embutido Redondo ES	6	400	67	55	6000	0.45
8.02.37.012.3	Panel Led Embutido Redondo ES	12	850	71	100	6000	0.50
8.02.37.018.3	Panel Led Embutido Redondo ES	18	1300	72	155	6000	0.50
8.02.37.024.2	Panel Led Embutido Redondo ES	24	1700	71	190	4000	0.50
8.02.37.024.3	Panel Led Embutido Redondo ES	24	1700	71	190	6000	0.50
8.02.11.012.2	Panel Led Embutido Cuadrado ES	12	850	71	100	4000	0.50
8.02.11.012.3	Panel Led Embutido Cuadrado ES	12	850	71	100	6000	0.50
8.02.11.018.2	Panel Led Embutido Cuadrado ES	18	1300	72	155	4000	0.50
8.02.11.018.3	Panel Led Embutido Cuadrado ES	18	1300	72	155	6000	0.50

Aplicaciones



Hogar



Mall



Colegios



Sala de reuniones



Hospitales

Especificaciones Generales

Especificaciones Técnicas

Ciclo de encendido/apagado	50,000
Consistencia del color (SDCM)	6
Luz Regulable	No
Color de acabado	Blanco
IP	IP20/IP44ext
IK	IK02
CRI	80
Controlador integrado	SI

Condiciones de Aplicación

Temperatura operativa	-10 ~ 40°C
Temperatura de aplicación	25°C
Entorno de almacenamiento	-25 ~ 50°C

Suministro Eléctrico

Frecuencia (Hz)	50/60
Voltaje (V)	220-240
AC/DC	AC

Propiedades

Material de la Carcasa	Metálico
Material óptico	PMMA

CE CB

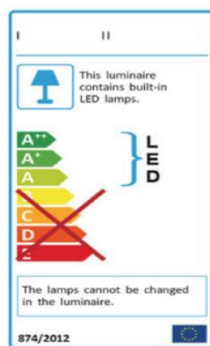

Datos Fotométricos

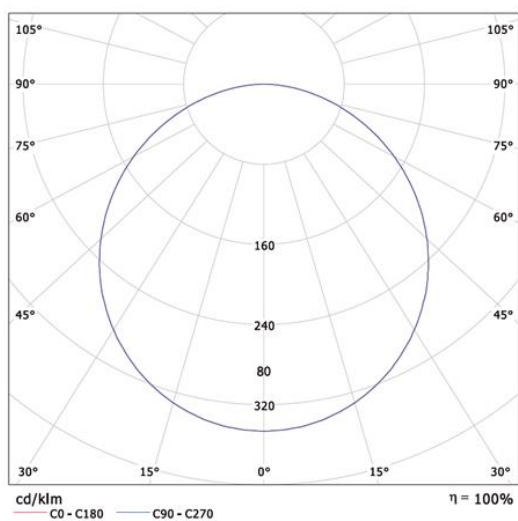

110° (6W / 12W / 18W / 24W)

Dimensiones

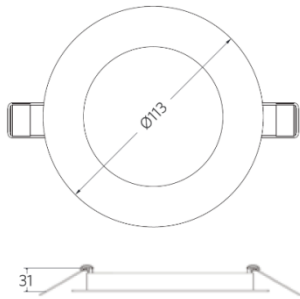

6 W

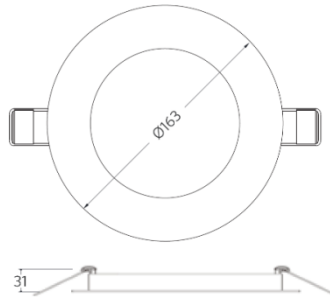

12 W

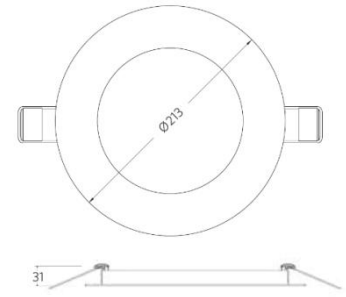

18 W

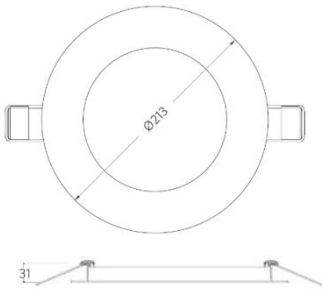

24 W

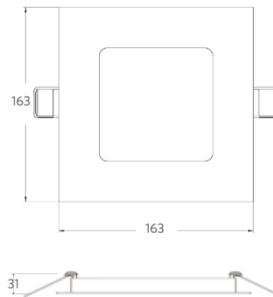

12 W

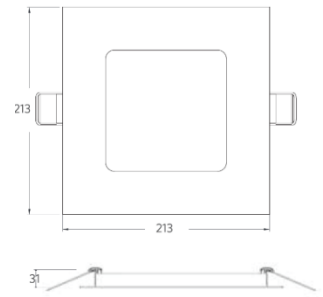

18 W

Caja Individual			Empaque Producto		
Código	Dimensiones (mm)	Peso unidades (Kg)	Dimensiones (mm)	Peso Bruto (Kg)	Unidades Por Caja
8.02.37.006.1	132x132x55	0.21	303x282x308	4.16	20
8.02.37.006.2	132x132x55	0.21	303x282x308	4.16	20
8.02.37.006.3	132x328x55	0.21	303x282x308	4.16	20
8.02.37.012.3	190x190x53	0.41	571x212x213	4.14	10
8.02.37.018.3	248x248x55	0.67	591x273x271	6.69	10
8.02.37.024.2	248x248x55	0.67	591x273x271	6.69	10
8.02.37.024.3	248x248x55	0.67	591x273x271	6.69	10
8.02.11.012.2	210x210x53	0.42	570x233x231	4.21	10
8.02.11.012.3	210x210x53	0.42	570x233x231	4.21	10
8.02.11.018.2	273x273x55	0.77	590x296x294	7.68	10
8.02.11.018.3	273x273x55	0.77	590x296x294	7.68	10